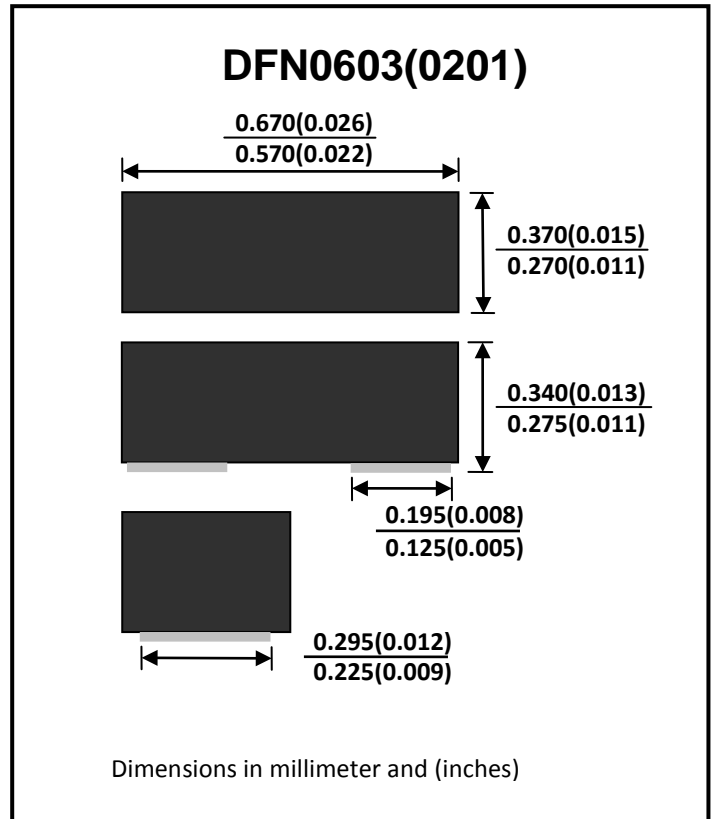

**CDB0130KRL****100mA 30V****Features**

- Low forward voltage
- Thin & leadless package
- Pb free version, RoHS compliant, and Halogen free

Mechanical Characteristics

- Case: DFN0603(0201) mold package
- Terminal: Sn/Au plated, solderable per MIL-STD-750, method 2026
- Marking: cathode band & L
- Weight: 0.0005 gram(approx.)

**Maximum Rating And Electrical Characteristics (at Ta=25°C unless otherwise noted)**

Parameter	Condition	Symbol	Min	Typ	Max	Unit
Repetitive peak reverse voltage		VRRM			30	V
Reverse voltage		VR			30	V
Average forward current		Io			100	mA
Forward current surge peak	8.3 ms single half sine-wave superimposed on rate load (JEDEC method)	IFSM			2	A
Storage/Operation temperature		T _{Sgt}	-40		150	°C
Junction temperature		T _J			100	°C
Forward voltage	IF=10mA	VF			0.37	V
Reverse current	VR=10V	IR			7	uA



Typical Characteristics

Fig.1 - Forward Characteristics

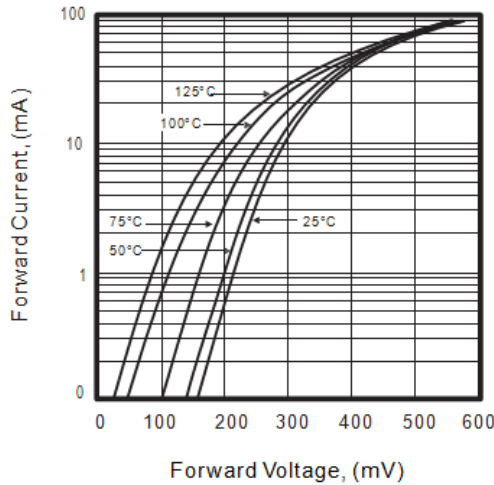

Fig.2 - Reverse Characteristics

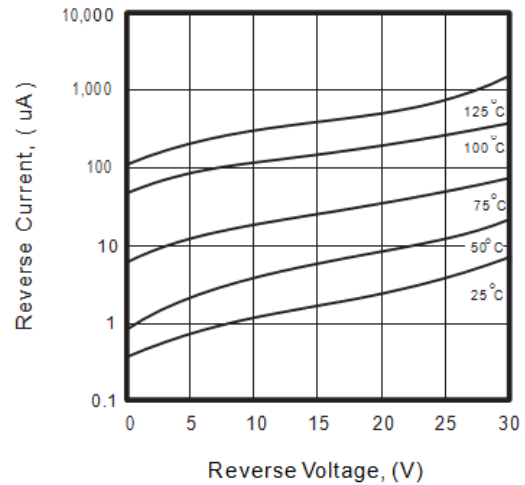

Fig.3 - Capacitance Between Terminals Characteristics

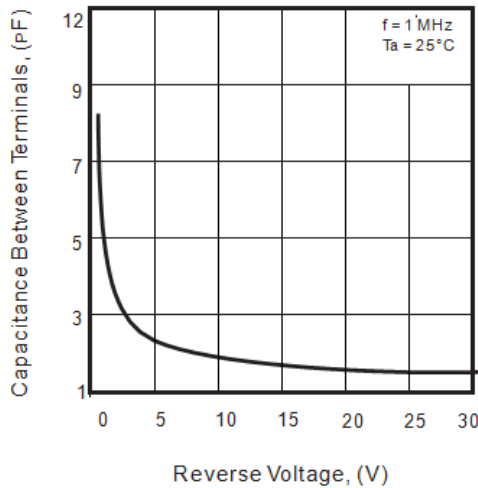
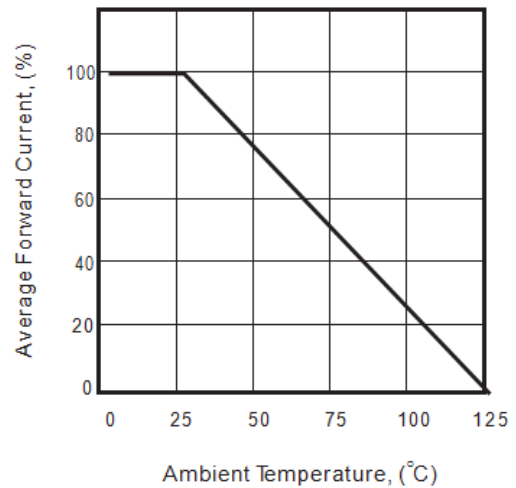
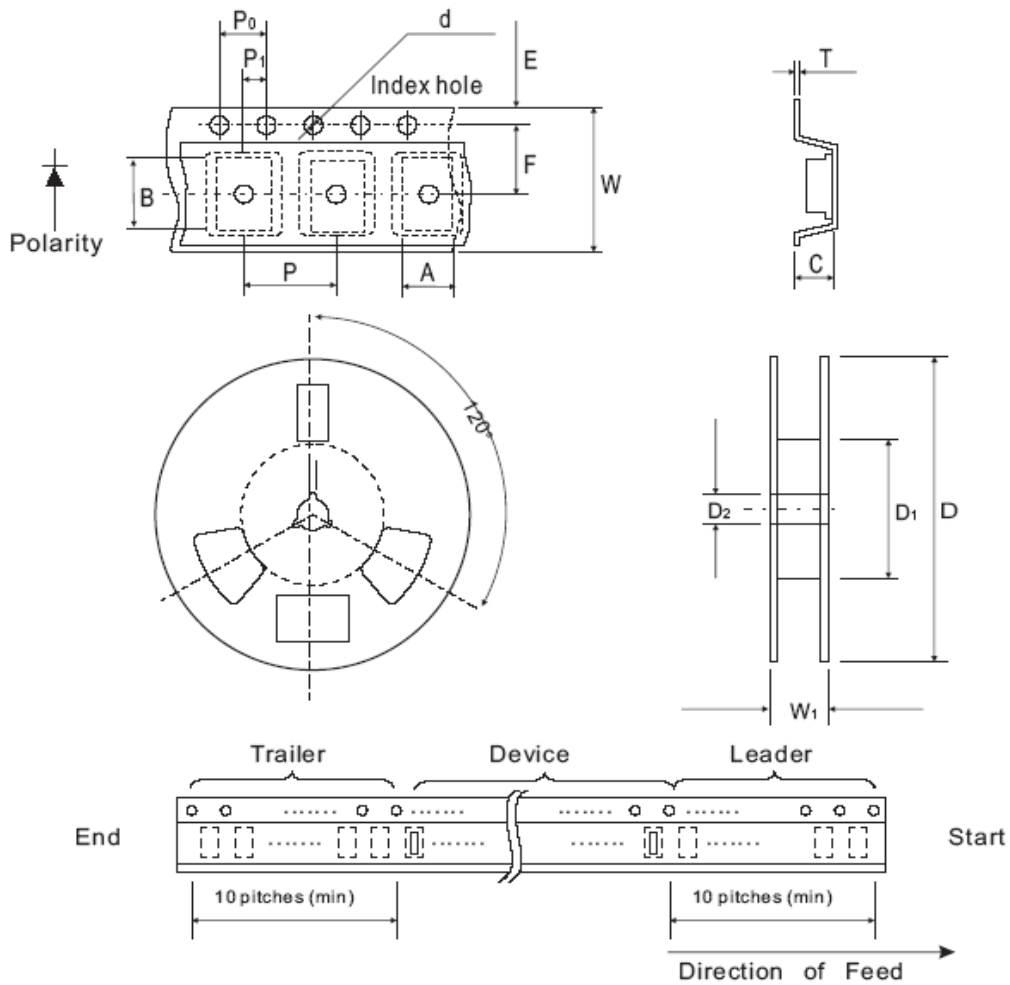

Fig.4 - Current Derating Curve





Packing Specification



Tape & Reel Dimensions

Package	Unit	A	B	C	d	D
DFN0603	mm	0.37±0.03	0.67±0.03	0.32±0.03	1.50±0.10	178±1
	inch	0.015±0.001	0.026±0.001	0.013±0.001	0.060±0.004	7.008±0.04

Package	Unit	D1	D2	E	F	P
DFN0603	mm	60MIN	13.0±0.20	1.75±0.10	3.5±0.10	2.0±0.03
	inch	2.362MIN	0.512±0.008	0.069±0.004	0.138±0.004	0.079±0.001

Package	Unit	P0	P1	T	W	W1
DFN0603	mm	4.0±0.10	2.0±0.10	0.18±0.05	8.0±0.10	13.5MAX
	inch	0.157±0.004	0.079±0.004	0.007±0.002	0.315±0.004	0.531MAX

**Standard Package**

Package	Reel Size	Qty/Reel
DFN0603	7"	10,000 pcs

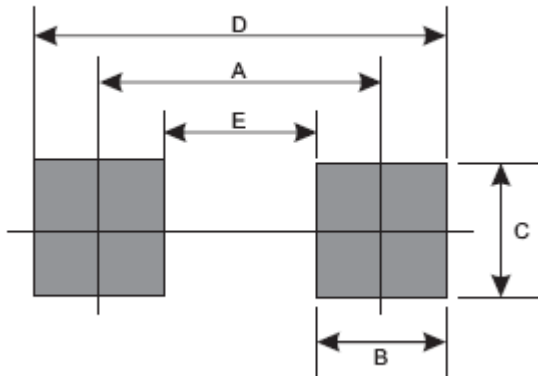
Recommended Soldering Footprint**Reflow Soldering**

Product Size	Dimension/ mm				
	A	B	C	D	E
DFN0603	0.420	0.220	0.360	0.640	0.200
	0.017"	0.009"	0.014"	0.025"	0.008"

Marking Code

Part Number	Marking Code
CDB0130KRL	L

**Disclaimers**

These products are not designed for use in applications where any failure or malfunction may result in personal injury, death or severe property or environmental damage such as medical, military, aircraft, space or life support equipments.